

GEBERIT KOREA PRODUCT PORTFOLIO

WE MANAGE WATERFLOWS



DESIGN
MEETS
FUNCTION

1905 년

알버트 에밀 게버트는 납 소재의 마감과 핏팅이 더해진 첫 목재 세정 수조를 개발하는 데 성공, 피닉스라는 브랜드로 제품을 생산

1964 년

세계 최초 벽매립형 물탱크 개발

2004 년

독일의 Mapress Group인수 합병

2014 년

Geberit의 벽매립형 물탱크 생산 50주년

2017 년

Geberit 브랜드로 위생도기 제품 출시

1874 년

카스퍼 멜키어 알버트 게버트 (1850~1909)는 스위스 취리히 인근 라퍼스빌이라는 오래된 마을에서 배관 업체 설립. 1900년대 초, 기업을 이은 그의 두 아들 알버트 에밀과 레오가 목재 세정 수조를 생산하기 시작

1952 년

세계 최초 PVC 세정 수조 생산

1999 년

창립 125주년 스위스 주식시장 상장

2005 년

Geberit International Sales AG 설립

2015 년

Keramag, Kolo, Twyford 등의 위생도기 브랜드를 보유한 핀란드의 Sanitec Group인수 합병

2019 년

무통기 배수 시스템 Geberit SuperTube System 출시

EVENTFUL HISTORY

1874년, 스위스에서 창립되어 현재까지 쌓아온 경험과 기술이 지금의 Geberit을 만들었습니다. Geberit은 위생 분야의 세계적인 리더로서 통합 시스템 솔루션을 제공 하고 있으며, 세계 위생 시장의 트렌드를 이끌고 있습니다.

Geberit은 40여개국 이상에서 12,000명 이상의 직원들과 함께 위생분야의 혁신과 안정성 그리고 자원 효율성을 위해 노력 하고 있습니다.

FROM BEGINNING TO END

GEBERIT SYSTEMS FOR THE WHOLE BUILDING

Geberit 시스템은 물의 '공급-사용- 배수' 에 이르는 통합 솔루션을 제공합니다.

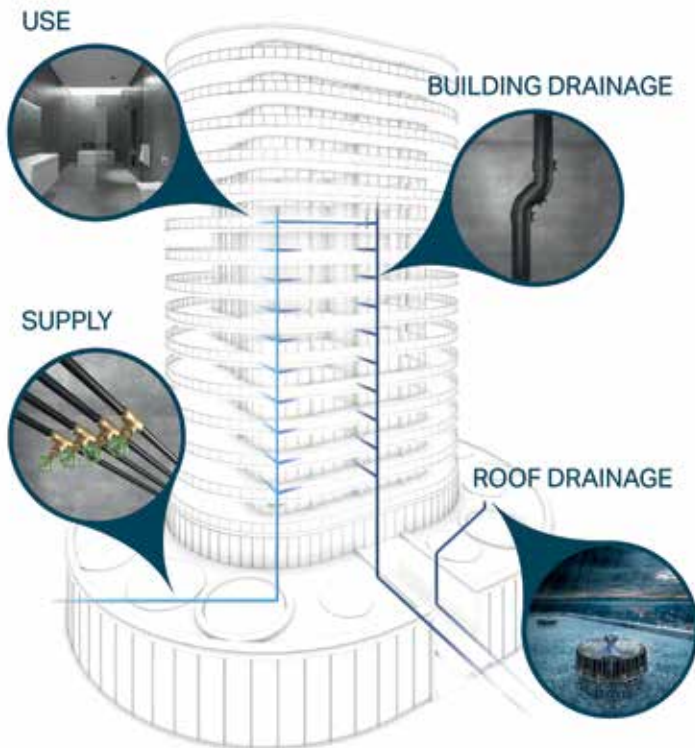

1 공급

Geberit의 급수 배관 시스템은 안정적으로 쉽게 설치 가능하고 고온, 고압에 강하며 소음 발생이 적습니다.

2 사용

Geberit은 디자인 및 내구성이 우수한 다양한 위생 도기를 생산하고 있습니다. Geberit은 위생설비 산업에서 125년이 넘는 세월 동안 꾸준히 세계 시장의 트렌드를 이끌고 있습니다.

3 배수

Geberit 오배수 시스템은 설치가 쉽고 뛰어난 성능과 안정성 그리고 방음 효과로 다양한 분야에 적용 가능합니다.

4 지붕 우배수 시스템

Geberit 지붕 우배수 시스템은 주거 시설 및 다양한 산업 분야에 경제적이고 효율적인 솔루션을 제공합니다.

ALL INCLUSIVE

Geberit은 제품 그 이상의 가치를 제공합니다. 지속적인 연구와 개발을 통해 실용적인 기술 및 감각적인 디자인을 겸비한 최고의 제품을 개발 합니다.

다양한 제품과 가치 있는 서비스를 제공 합니다.



위생 도기류,
가구류



위생
시스템



배관
시스템



운반
서비스



설치
부속



교육
서비스



사양 및
설계



기술
지원



A/S
서비스

DESIGN MEETS FUNCTION

고품질 위생도기와 현대적인
가구로 독특한 분위기를
만들어보세요 . 혁신적인
시스템과 고급스러운
디자인은 Geberit 배관재와
함께 안정적인 벽매립
시스템을 만들 수 있습니다.

GEBERIT SHOWER DRAINS

욕실바닥과 벽에 자연스럽게
어울리는 Geberit 샤워 배수
시스템은 우리의 욕실에
현대적인 감각을 더해 줍니다.



GEBERIT ACTUATOR PLATES

다양한 디자인의 물내림 버튼이
준비되어 있어, 여러 환경과 개인
취향에 따라 선택할 수 있습니다.
주거용, 공용 화장실에 모두 설치
할 수 있습니다.



GEBERIT AQUACLEAN

Geberit AquaClean 비데
양변기는 일반 비데와 다른 그
이상의 가치를 보여드립니다.





GEBERIT FURNITURE

거울부터 선반, 캐비닛까지 Geberit 은 아름다운 디자인의 다양한 욕실용 가구를 제공합니다. 모든 제품은 방수 소재로 제작되었습니다.



GEBERIT FLOOR DRAINS

Geberit의 바닥 배수는 기존 배수구보다 작은 사이즈이지만, 매력적인 디자인과 우수한 성능을 자랑합니다.



GEBERIT CERAMICS

Geberit은 세면대부터 양변기, 소변기까지 위생도기 전 제품을 생산합니다. 욕실에 필요한 모든 것이 준비되어 있습니다.

DESIGN
MEETS
FUNCTION

KNOW-HOW INSTALLED

Geberit의 배관 시스템은 위생 기술 분야에서 125년간 축적된 주거, 산업 및 공공 건물의 급수 시스템 부터 지붕 및 건물에 설치되는 배수시스템까지의 Know-how를 가지고 있습니다. 또한 수리학, 방화, 방음, 환경 분야 등 폭 넓은 범위의 최첨단 기술을 제공합니다.



GEBERIT MEPLA

3종 복합 급수 배관은 설치가 매우 쉬우며 다양한 분야에 사용됩니다.



GEBERIT HDPE

다양한 환경에서 사용가능한 Geberit 배수 배관은 강한 내충격성과 내열성을 자랑하고 선제작이 가능한 HDPE 재질로 생산되며 반영구적으로 사용할 수 있습니다.

GEBERIT PREWALL INSTALLATION

민벽 및 선반 구조의 사전 조립 가능한 제품으로 모든 건축 분야에 맞춤형 솔루션으로 적용 할 수 있으며, 벽 쪽에 대한 방음 효과도 있습니다.



☆☆☆

GEBERIT MAPRESS

총 4가지 재질의 배관으로 구성 되어 전반적인 산업 분야에 적합한 금속 배관 시스템입니다. 주거 및 다양한 산업 분야에 적용 가능합니다.

**KNOW
HOW
INSTALLED**

CONTENTS

12 CONCEALED CISTERNS



26 GEBERIT BATHROOM CERAMICS

15 ACTUATOR PLATES



30 GEBERIT AQUACLEAN

36

SHOWER
DRAINS



40

PUBLIC
SOLUTIONS



48

GEBERIT
BATHROOM
COLLECTION



60

WASTE WATER
DRAINAGE SYSTEMS



62

WATER SUPPLY
SYSTEMS

A DIRECT PATH TO THE SANITARY WALL

GEBERIT GIS INSTALLATION SYSTEMS

Geberit GIS 시스템은 프로파일(아연도금 파이프)과 전용 연결 부속을 사용하여 현장에서 빠르게 설치할 수 있습니다.

프로파일에 있는 연결 부위에 각 부품을 빠르고 안정적으로 설치할 수 있는 최적의 제품입니다. Geberit 프로파일과 연결 부속은 용접 및 특수 장비 없이 설치될 수 있습니다.



↑ 한번에 최대 4개의 Geberit GIS 프로파일을 절단할 수 있습니다.



↑ Geberit GIS 프로파일 설치: 단 한번의 클릭으로 모든 것이 설치됩니다.



↑ 코르크 방음 베이스가 부착된 Geberit GIS mounting bracket은 벽매립 시스템의 안정적인 설치와 방음 효과를 제공합니다.



↑ Geberit GIS는 빠르고 안정적으로 설치됩니다.



←
 민벽 또는 선반 형태의 벽구조물에
 Geberit GIS 설치 시스템이 설치될
 경우 경제적이며 빠르고 안전하게
 설치가 가능합니다.

Geberit GIS는 다양한 욕실 벽구조물에 빠르고
 안정적이며 경제적인 설치가 가능합니다. 다양한
 검사와 표준 인증을 거친 방음 및 방화 기능도
 포함되어 있습니다.



FOR UNIVERSAL USE

Geberit GIS는 다양한 구조의 욕실에 설치 할 수
 있습니다. 작은 욕실부터 큰 욕실까지, 각각 현장
 조건에 맞게 설치가 가능합니다.

TOOL-FREE INSTALLATION

Geberit GIS는 별도의 도구 없이 설치 가능하며,
 구조적으로 타협하지 않으면서 합리적인 욕실
 솔루션의 기준을 제공합니다.



- 1 Geberit GIS는 다양한 구조의 욕실에 설치 할 수 있습니다.
- 2 Geberit GIS를 설치하여 욕실을 다양하게 디자인 할 수
 있습니다.

GEBERIT CONCEALED CISTERNS

SOLUTIONS FOR MODERN BATHROOMS



→ Geberit Smyle WC with Sigma50 actuator plate

GEBERIT CONCEALED SOLUTIONS

THE TRADITION OF HIDING CISTERNS

전 세계에 7천만개 이상이 설치되어 있으며, 이는 제품의 안전성을 입증합니다. 또한, Geberit의 HDPE 소재의 물탱크는 55년 이상의 경험과 품질로 신뢰를 받아오고 있습니다.

EVENTFUL HISTORY, CONSTANT INNOVATION.

Geberit은 1964년 부터 제품의 개선과 발전을 위해 노력하고 있으며 물탱크의 품질과 기능을 지속적으로 개발하고 있습니다.



BEAUTIFUL DESIGN

물내림 누름 버튼은 욕실 디자인에 포인트가 될 수 있습니다. Geberit 벽걸이형 양변기와 함께 다양한 디자인을 제공합니다.



INNOVATIVE AND FUNCTIONAL DESIGN

일부 물내림 누름버튼은 지문방지 코팅이 되어 있으며 공용화장실에서도 사용 가능한 강한 내구성을 가지고 있습니다. 옵션에 따라 냄새 제거 장치와 같이 설치 할 수 있습니다.



WITHSTANDING HEAVY LOAD

Geberit의 벽걸이 시스템은 400kg의 무게를 견딜 수 있도록 설계되어 최종 테스트 후 판매가 됩니다.



SAVING WATER

Geberit의 벽걸이 시스템은 Dual Flush 로 물 소비량을 지속적으로 줄일 수 있습니다.



OPENING SPACE

벽매립형 시스템을 통해 욕실 공간이 더욱 넓어 집니다.



EASY TO CLEAN

벽걸이형 시스템을 통해 바닥 공간의 청소가 더욱 용이하여 위생적 입니다.



TOOL-FREE MAINTENANCE

누름 버튼과 벽매립형 물탱크를 유지보수 하기 위한 별도의 공구가 필요 없습니다.



PREMIUM QUALITY

Geberit의 모든 제품은 수 십년 동안 입증된 스위스 기술이 적용되어 매우 높은 안정성과 내구성으로 세계에서 가장 안전한 위생 제품 입니다.



↑
1964년 최초의 숨겨진 벽매립형 물탱크



↑
현대 기술을 사용한 벽매립형 물탱크

GEBERIT SIGMA CONCEALED CISTERNS

Sigma Duofix, Siphonic

→ 224.035.00.1

Thickness: 120mm
 Height: 1,105mm
 Flush large: 6L
 Flush small: 4L
 Flow pressure: 0.1 - 10 bar

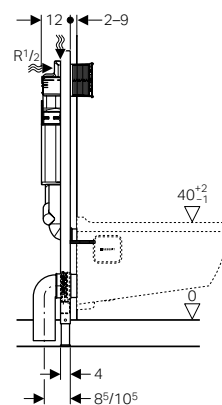
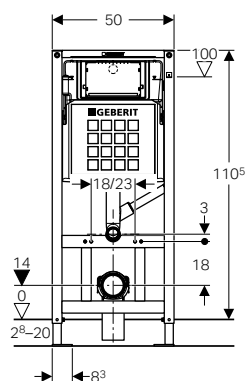

Sigma Duofix, Washdown

→ 224.212.00.1

Thickness: 120mm
 Height: 1,135mm
 Flush large: 6L
 Flush small: 3L
 Flow pressure: 0.1 - 10 bar

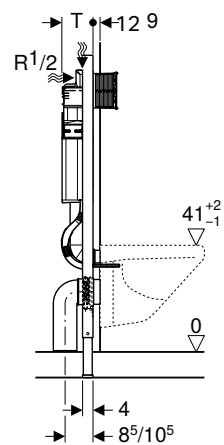
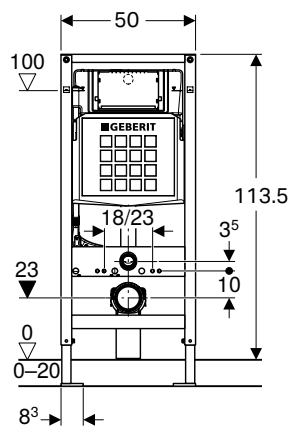

GEBERIT SIGMA ACTUATOR PLATES

Sigma80

Flush technology:
dual flush, infrared

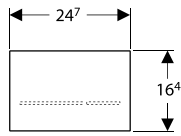

→ **116.090.SG.1**
Plate: Black glass
Material: Glass



→ **116.090.SM.1**
Plate: Reflective glass
Material: Glass

* Installation set required -
→ Art no: 115.861.00.1

Sigma70

Flush technology:
dual flush

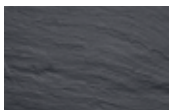
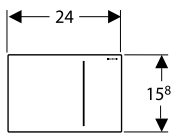

→ **115.620.00.1**
Plate: Customisable



→ **115.620.FW.1**
Plate: Stainless steel brushed
Material: Stainless steel



→ **115.620.SI.1**
Plate: White glass
Material: Glass



→ **115.620.SJ.1**
Plate: Black glass
Material: Glass



→ **115.620.SQ.1**
Plate: UMBER glass
Material: Glass

Sigma60

Flush technology:
dual flush

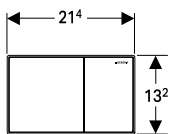

→ **115.640.GH.1**
Buttons: Brushed chrome,
easy-to-clean coated
Frame: Bright chrome
Stripes: Bright chrome
Material: Die-cast zinc



→ **115.640.SI.1**
Buttons: White glass
Frame: Bright chrome
Stripes: Mirrored
Material: Glass, Die-cast zinc



→ **115.640.SJ.1**
Buttons: Black glass
Frame: Bright chrome
Stripes: Mirrored
Material: Glass, Die-cast zinc



→ **115.640.SQ.1**
Buttons: UMBER glass
Frame: Bright chrome
Stripes: Mirrored
Material: Glass, Die-cast zinc

* Installation set required -
→ Art no: 243.168.00.1

* Brushed chrome cover frame:
→ Art no: 115.641.GH.1
(easy-to-clean)
→ Art no: 115.641.21.1

GEBERIT SIGMA ACTUATOR PLATES

Sigma50

Flush technology:
dual flush

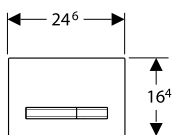

NEW

→ **115.670.00.2**
Plate: Customisable
Buttons: Red gold
Material: Die-cast zinc, Plastic



NEW

→ **115.671.00.2**
Plate: Customisable
Buttons: Black chrome
Material: Die-cast zinc, Plastic



NEW

→ **115.672.00.2**
Plate: Customisable
Buttons: Brass
Material: Die-cast zinc, Plastic



→ **115.788.00.2**
Plate: Customisable
Buttons: Easy-to-clean coated
Material: Die-cast zinc



→ **115.788.DW.2**
Plate: Jet black RAL 9005
Buttons: Easy-to-clean coated
Material: Die-cast zinc, Plastic



NEW

→ **115.670.11.2**
Plate: White
Buttons: Red gold
Material: Plastic



NEW

→ **115.671.11.2**
Plate: White
Buttons: Black chrome
Material: Plastic



NEW

→ **115.672.11.2**
Plate: White
Buttons: Brass
Material: Plastic



→ **115.788.11.2**
Plate: White alpine
Buttons: Easy-to-clean coated
Material: Die-cast zinc, Plastic



→ **115.788.GH.2**
Plate: Brushed chrome
Buttons: Easy-to-clean coated
Material: Die-cast zinc, Brass



NEW

→ **115.670.DW.2**
Plate: Black
Buttons: Red gold
Material: Plastic



NEW

→ **115.671.DW.2**
Plate: Black
Buttons: Black chrome
Material: Plastic



NEW

→ **115.672.DW.2**
Plate: Black
Buttons: Brass
Material: Plastic



→ **115.788.21.2**
Plate: Bright chrome
Buttons: Easy-to-clean coated
Material: Die-cast zinc, Brass



→ **115.788.SD.2**
Plate: Smoked glass reflective
Buttons: Easy-to-clean coated
Material: Die-cast zinc, Glass



NEW

→ **115.670.JM.2**
Plate: Mustang slate
Buttons: Red gold
Material: Slate



NEW

→ **115.671.JM.2**
Plate: Mustang slate
Buttons: Black chrome
Material: Slate



NEW

→ **115.672.JM.2**
Plate: Mustang slate
Buttons: Brass
Material: Slate



→ **115.788.JM.2**
Plate: Mustang slate
Buttons: Easy-to-clean coated
Material: Slate



→ **115.788.SQ.2**
Plate: Umber glass
Buttons: Easy-to-clean coated
Material: Die-cast zinc, Glass



NEW

→ **115.670.JV.2**
Plate: Concrete
Buttons: Red gold
Material: Concrete



NEW

→ **115.671.JV.2**
Plate: Concrete
Buttons: Black chrome
Material: Concrete



NEW

→ **115.672.JV.2**
Plate: Concrete
Buttons: Brass
Material: Concrete



→ **115.788.JV.2**
Plate: Concrete
Buttons: Chrome
Material: Concrete



→ **115.788.TG.2**
Plate: Sand glass
Buttons: Easy-to-clean coated
Material: Die-cast zinc, Glass



NEW

→ **115.670.JX.2**
Plate: Black walnut
Buttons: Red gold
Material: Wood



NEW

→ **115.671.JX.2**
Plate: Black walnut
Buttons: Black chrome
Material: Wood



NEW

→ **115.672.JX.2**
Plate: Black walnut
Buttons: Brass
Material: Wood



→ **115.788.JX.2**
Plate: Black walnut
Buttons: Chrome
Material: Wood

Sigma30

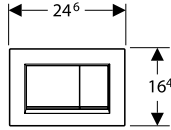

Flush technology:
dual flush



NEW

→ **115.883.01.1**
Plate: White
Buttons: White
Stripes: White matt
Material: Easy-to-clean coated



NEW

→ **115.883.16.1**
Plate: Black
Buttons: Black
Stripes: Black matt
Material: Easy-to-clean coated



→ **115.883.JT.1**
Plate: Matt white
Buttons: Matt white
Stripes: Bright chrome
Material: Easy-to-clean coated

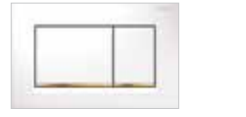

→ **115.883.KK.1**
Plate: White
Buttons: White
Stripes: Gold
Material: Plastic



→ **115.883.KN.1**
Plate: Matt chrome
Buttons: Matt chrome
Stripes: Bright chrome
Material: Plastic

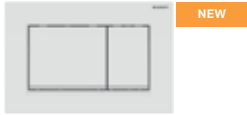

NEW

→ **115.883.11.1**
Plate: White
Buttons: White
Stripes: White gloss
Material: Plastic



NEW

→ **115.883.DW.1**
Plate: Black
Buttons: Black
Stripes: Black gloss
Material: Plastic



→ **115.883.KH.1**
Plate: Bright chrome
Buttons: Bright chrome
Stripes: Matt chrome
Material: Plastic



→ **115.883.KL.1**
Plate: White
Buttons: Matt chrome
Stripes: Matt chrome
Material: Plastic



→ **115.883.14.1**
Plate: Matt black
Buttons: Matt black
Stripes: Bright chrome
Material: Easy-to-clean coated



→ **115.883.JQ.1**
Plate: Matt chrome
Buttons: Matt chrome
Stripes: Bright chrome
Material: Easy-to-clean coated



→ **115.883.KJ.1**
Plate: White
Buttons: White
Stripes: Bright chrome
Material: Plastic



→ **115.883.KM.1**
Plate: Black
Buttons: Black
Stripes: Bright chrome
Material: Plastic

Sigma20

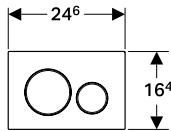

Flush technology:
dual flush



NEW

→ **115.882.01.1**
Plate: White matt
Buttons: White matt
Ring: White
Material: Easy-to-clean coated



NEW

→ **115.882.16.1**
Plate: Black matt
Buttons: Black matt
Ring: Black
Material: Easy-to-clean coated



→ **115.882.JT.1**
Plate: Matt white
Buttons: Matt white
Ring: Bright chrome
Material: Easy-to-clean coated



→ **115.882.KK.1**
Plate: White
Buttons: White
Ring: Gold
Material: Plastic



→ **115.882.KN.1**
Plate: Matt chrome
Buttons: Matt chrome
Ring: Bright chrome
Material: Plastic



NEW

→ **115.882.11.1**
Plate: White
Buttons: White
Ring: White matt
Material: Plastic



NEW

→ **115.882.DW.1**
Plate: Black
Buttons: Black
Ring: Black matt
Material: Plastic



→ **115.882.KH.1**
Plate: Bright chrome
Buttons: Bright chrome
Ring: Matt chrome
Material: Plastic



→ **115.882.KL.1**
Plate: White
Buttons: Matt chrome
Ring: Matt chrome
Material: Plastic



→ **115.882.SN.1**
Plate: Stainless steel brushed
Buttons: Stainless steel brushed
Ring: Polished
Material: Easy-to-clean coated



→ **115.882.14.1**
Plate: Matt black
Buttons: Matt black
Ring: Bright chrome
Material: Easy-to-clean coated



→ **115.882.JQ.1**
Plate: Matt chrome
Buttons: Matt chrome
Ring: Bright chrome
Material: Easy-to-clean coated



→ **115.882.KJ.1**
Plate: White
Buttons: White
Ring: Bright chrome
Material: Plastic



→ **115.882.KM.1**
Plate: Black
Buttons: Black
Ring: Bright chrome
Material: Plastic



→ **115.889.SN.1** (lockable)
Plate: Stainless steel brushed
Buttons: Stainless steel brushed
Ring: Polished
Material: Easy-to-clean coated

Sigma21

Flush technology:
dual flush

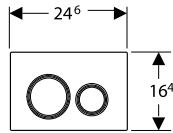

NEW

→ **115.650.00.1**
Plate & Buttons: Customisable
Ring: Red gold
Material: Die-cast zinc



NEW

→ **115.651.00.1**
Plate & Buttons: Customisable
Ring: Black chrome
Material: Die-cast zinc



NEW

→ **115.652.00.1**
Plate & Buttons: Customisable
Ring: Brass
Material: Die-cast zinc



NEW

→ **115.761.00.1**
Plate & Buttons: Coral orange
Ring: Bright chrome
Material: Decorative laminate



→ **115.884.00.1**
Plate & Buttons: Customisable
Ring: Bright chrome
Material: Die-cast zinc



NEW

→ **115.650.JM.1**
Plate & Buttons: Mustang slate
Ring: Red gold
Material: Slate



NEW

→ **115.651.JM.1**
Plate & Buttons: Mustang slate
Ring: Black chrome
Material: Slate



NEW

→ **115.652.JM.1**
Plate & Buttons: Mustang slate
Ring: Brass
Material: Slate



NEW

→ **115.761.00.2**
Plate & Buttons: Abyss blue
Ring: Bright chrome
Material: Decorative laminate



→ **115.884.JM.1**
Plate & Buttons: Mustang slate
Ring: Bright chrome
Material: Slate



NEW

→ **115.650.JV.1**
Plate & Buttons: Concrete
Ring: Red gold
Material: Concrete



NEW

→ **115.651.JV.1**
Plate & Buttons: Concrete
Ring: Black chrome
Material: Concrete



NEW

→ **115.652.JV.1**
Plate & Buttons: Concrete
Ring: Brass
Material: Concrete



NEW

→ **115.761.00.3**
Plate & Buttons: Coral pink
Ring: Bright chrome
Material: Decorative laminate



→ **115.884.JV.1**
Plate & Buttons: Concrete
Ring: Bright chrome
Material: Concrete



NEW

→ **115.650.JX.1**
Plate & Buttons: Black walnut
Ring: Red gold
Material: Wood



NEW

→ **115.651.JX.1**
Plate & Buttons: Black walnut
Ring: Black chrome
Material: Wood



NEW

→ **115.652.JX.1**
Plate & Buttons: Black walnut
Ring: Brass
Material: Wood



NEW

→ **115.761.00.4**
Plate & Buttons: Camel
Ring: Bright chrome
Material: Decorative laminate



→ **115.884.JX.1**
Plate & Buttons: Black walnut
Ring: Bright chrome
Material: Wood



NEW

→ **115.650.SI.1**
Plate & Buttons: White
Ring: Red gold
Material: Glass



NEW

→ **115.651.SI.1**
Plate & Buttons: White
Ring: Black chrome
Material: Glass



NEW

→ **115.652.SI.1**
Plate & Buttons: White
Ring: Brass
Material: Glass



NEW

→ **115.761.00.5**
Plate & Buttons: Beige
Ring: Bright chrome
Material: Decorative laminate



→ **115.884.SI.1**
Plate & Buttons: White
Ring: Bright chrome
Material: Glass



NEW

→ **115.650.SJ.1**
Plate & Buttons: Black
Ring: Red gold
Material: Glass



NEW

→ **115.651.SJ.1**
Plate & Buttons: Black
Ring: Black chrome
Material: Glass



NEW

→ **115.652.SJ.1**
Plate & Buttons: Black
Ring: Brass
Material: Glass



NEW

→ **115.761.00.6**
Plate & Buttons: Grey linen
Ring: Bright chrome
Material: Decorative laminate



→ **115.884.SJ.1**
Plate: Black
Ring: Bright chrome
Material: Glass



NEW

→ **115.761.00.I**
Plate & Buttons: Rouge leather
Ring: Bright chrome
Material: Decorative laminate



NEW

→ **115.761.00.7**
Plate & Buttons: Dark Rock
Ring: Bright chrome
Material: Decorative laminate



→ **115.884.TG.1**
Plate & Buttons: Sand glass
Ring: Bright chrome
Material: Glass

GEBERIT SIGMA ACTUATOR PLATES

Sigma10

Flush technology:
dual flush, infrared

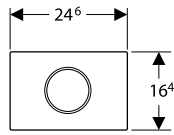

→ **115.907.KH.1** (mains)
→ **115.908.KH.1** (battery)
Plate: Bright chrome
Ring: Matt chrome
Material: Plastic



→ **115.907.KK.1** (mains)
→ **115.908.KK.1** (battery)
Plate: White
Ring: Gold-plated
Material: Plastic



→ **115.907.KM.1** (mains)
→ **115.908.KM.1** (battery)
Plate: Black
Ring: Bright chrome
Material: Plastic



→ **115.907.SN.1** (mains)
→ **115.908.SN.1** (battery)
Plate: Stainless steel brushed
Ring: Polished
Material: Stainless steel



With manual flush
→ **115.890.SN.5** (mains)
→ **115.891.SN.5** (battery)
Plate: Stainless steel brushed
Ring: Polished
Material: Stainless steel



→ **115.907.KJ.1** (mains)
→ **115.908.KJ.1** (battery)
Plate: White
Ring: Bright chrome
Material: Plastic



→ **115.907.KL.1** (mains)
→ **115.908.KL.1** (battery)
Plate: White
Ring: Matt chrome
Material: Plastic



→ **115.907.KN.1** (mains)
→ **115.908.KN.1** (battery)
Plate: Matt chrome
Ring: Bright chrome
Material: Plastic

* Installation set required for
mains operation plates -
→ Art no: 115.861.00.1

Sigma01

Flush technology:
dual flush

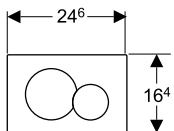

→ **115.770.11.5**
Plate: White alpine
Buttons: White alpine
Material: Plastic



→ **115.770.46.5**
Plate: Matt chrome
Buttons: Matt chrome
Material: Plastic



→ **115.770.DW.5**
Plate: Jet black RAL 9005
Buttons: Jet black RAL 9005
Material: Plastic



→ **115.770.LA.5**
Plate: White
Buttons: Yellow / Green
Material: Plastic



→ **115.770.JQ.5**
Plate: Matt chrome
Buttons: Easy-to-clean coated
Material: Plastic



→ **115.770.21.5**
Plate: Brushed chrome
Buttons: Brushed chrome
Material: Plastic



→ **115.770.DT.5**
Plate: Special brass galvanised
Buttons: Special brass galvanised
Material: Plastic



→ **115.770.KA.5**
Plate: Bright chrome
Buttons: Matt chrome
Material: Plastic



→ **115.770.LB.5**
Plate: White
Buttons: Blue / Red
Material: Plastic

GEBERIT KAPPA CONCEALED CISTERNS

Kappa GIS, Siphonic

→ 224.179.00.1

Thickness: 150mm
Height: 890mm
Flush large: 6L
Flush small: 4L
Flow pressure: 0.1 ~ 10 bar



NEW

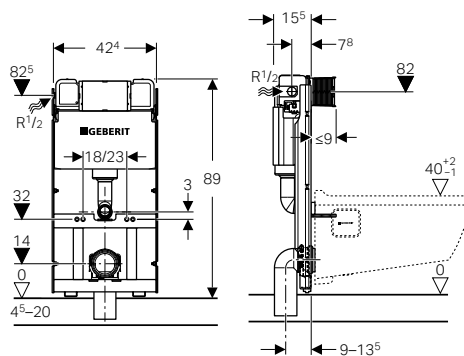

Kappa Duofix, Washdown

→ 224.157.00.1

Thickness: 150mm
Height: 820mm
Flush large: 6L
Flush small: 3L
Flow pressure: 0.1 ~ 10 bar

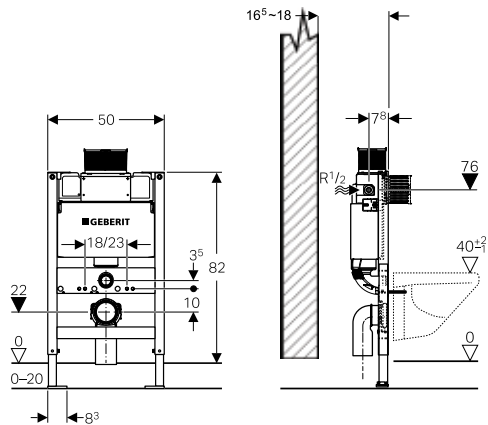

GEBERIT KAPPA ACTUATOR PLATES

Kappa50

Flush technology:
dual flush

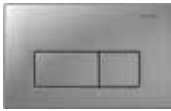
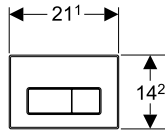

→ **115.258.00.1**
Plate: Stainless steel brushed
Buttons: Stainless steel brushed
Material: Stainless steel



→ **115.260.11.1**
Plate: White alpine
Buttons: White alpine
Material: Die-cast zinc



→ **115.260.21.1**
Plate: Bright chrome
Buttons: Bright chrome
Material: Die-cast zinc



→ **115.260.46.1**
Plate: Matt chrome
Buttons: Matt chrome
Material: Die-cast zinc

Kappa21

Flush technology:
dual flush

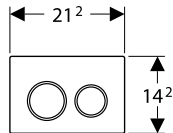

→ **115.240.KH.1**
Plate: Bright chrome
Buttons: Bright chrome
Ring: Matt chrome
Material: Plastic



→ **115.240.KJ.1**
Plate: White
Buttons: White
Ring: Bright chrome
Material: Plastic



→ **115.240.KK.1**
Plate: White
Buttons: White
Ring: Gold-plated
Material: Plastic



→ **115.240.KL.1**
Plate: White
Buttons: Matt chrome
Ring: Matt chrome
Material: Plastic



→ **115.240.KM.1**
Plate: Black
Buttons: Black
Ring: Bright chrome
Material: Plastic



→ **115.240.KN.1**
Plate: Matt chrome
Buttons: Matt chrome
Ring: Bright chrome
Material: Plastic

Kappa20

Flush technology:
dual flush

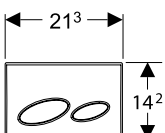

→ **115.228.11.1**
Plate: White alpine
Buttons: White alpine
Material: Plastic



→ **115.228.21.1**
Plate: Bright chrome
Buttons: Bright chrome
Material: Plastic



→ **115.228.46.1**
Plate: Matt chrome
Buttons: Matt chrome
Material: Plastic

GEBERIT ALPHA CONCEALED CISTERNS

Alpha Duofix, Siphonic

Top Actuation

→ 224.014.00.1

Thickness: 110mm
 Height: 805mm
 Flush large: 9L
 Flush small: 3L
 Flow pressure: 0.1 - 10 bar

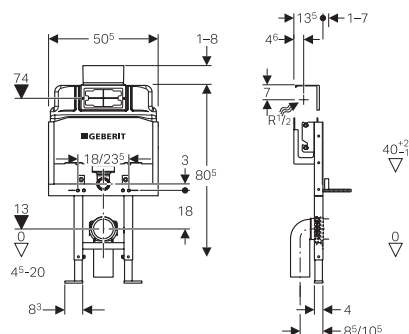

Front Actuation

→ 224.189.00.1

Thickness: 110mm
 Height: 1,045mm
 Flush large: 9L
 Flush small: 3L
 Flow pressure: 0.1 - 10 bar

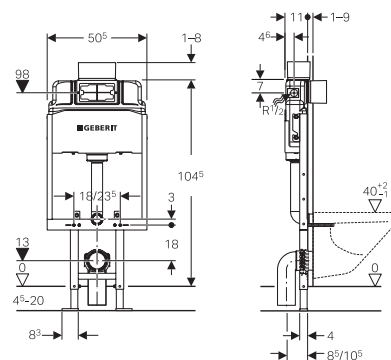

Alpha Duofix, Washdown

Front Actuation

→ 224.185.00.1

Thickness: 110mm
 Height: 1,065mm
 Flush large: 6L
 Flush small: 3L
 Flow pressure: 0.1 - 10 bar

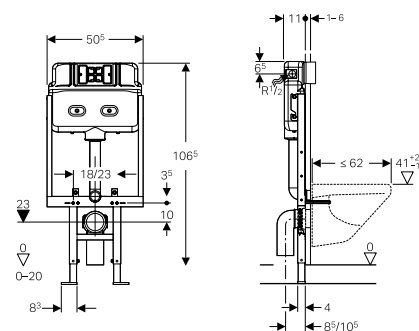

GEBERIT ALPHA ACTUATOR PLATES

Alpha50

Flush technology:
dual flush

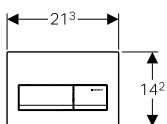

→ **115.060.DW.1**
Plate: Jet black RAL 9005
Material: Plastic



→ **115.060.11.1**
Plate: White alpine
Material: Plastic



→ **115.061.11.1** (Top actuation only)
Plate: White alpine
Material: Plastic

Alpha30

Flush technology:
dual flush

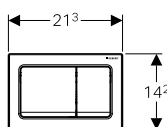

→ **115.055.21.1**
Plate: Bright chrome
Material: Plastic



→ **115.055.46.1**
Plate: Matt chrome
Material: Plastic



→ **115.055.11.1**
Plate: White alpine
Material: Plastic



→ **115.054.11.1** (Top actuation only)
Plate: White alpine
Material: Plastic

Alpha15

Flush technology:
dual flush

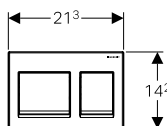

→ **115.045.21.1**
Plate: Bright chrome
Material: Plastic



→ **115.045.46.1**
Plate: Matt chrome
Material: Plastic

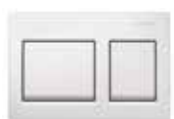

→ **115.045.11.1**
Plate: White alpine
Material: Plastic

Alpha10

Flush technology:
dual flush

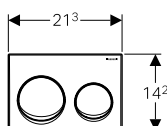

→ **115.040.21.1**
Plate: Bright chrome
Material: Plastic



→ **115.040.46.1**
Plate: Matt chrome
Material: Plastic



→ **115.040.11.1**
Plate: White alpine
Material: Plastic

GEBERIT REMOTE FLUSH ACTUATOR PLATES

Pneumatic Type 70

Flush technology:
dual flush
For Sigma Cistern only

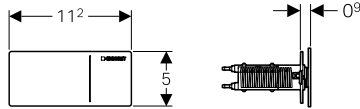

→ **115.630.FW.1**
Plate: Stainless steel
Material: Stainless steel brushed



→ **115.630.SI.1**
Plate: White glass
Material: Glass



→ **115.630.SJ.1**
Plate: Black glass
Material: Glass



→ **115.630.SQ.1**
Plate: Umber glass
Material: Glass

Pneumatic Actuator

Flush technology:
dual flush

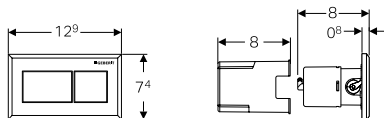

→ **115.932.KA.1**
Plate: Bright chrome
Buttons: Matt chrome
Material: Plastic



→ **115.932.KT.1**
Plate: Glossy white
Buttons: Brushed chrome
Material: Plastic



→ **115.932.KV.1**
Plate: Glossy black
Buttons: Brushed chrome
Material: Plastic



→ **115.932.GH.1**
Plate: Brushed chrome
Buttons: Brushed chrome
Material: Die cast zinc

Pneumatic Type 10

Flush technology:
dual flush

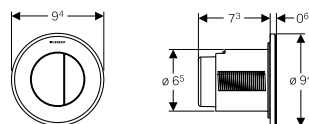

→ **116.055.KH.1**
Collar & Buttons: Bright chrome
Ring: Matt chrome
Material: Plastic



→ **116.055.KJ.1**
Collar & Buttons: White
Ring: Bright chrome
Material: Plastic



→ **116.055.KK.1**
Collar & Buttons: White
Ring: Gold
Material: Plastic



→ **116.055.KM.1**
Collar & Buttons: Black
Ring: Bright chrome
Material: Plastic



→ **116.055.KN.1**
Collar & Buttons: Matt chrome
Ring: Bright chrome
Material: Plastic

Pneumatic Type 01

Flush technology:
dual flush

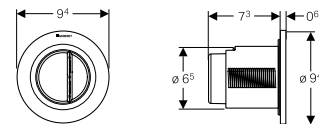

→ **116.042.11.1**
Collar: White alpine
Buttons: White alpine
Material: Plastic



→ **116.042.21.1**
Collar: Bright chrome
Buttons: Bright chrome
Material: Plastic



→ **116.042.46.1**
Collar: Matt chrome
Buttons: Matt chrome
Material: Plastic



→ Geberit iCon wall-hung WC with Geberit Pneumatic Type 10 remote flush actuator

GEBERIT BATHROOM CERAMICS

BETTER BATHROOMS



→ Geberit PurityS wall-hung WC with Sigma50 actuator plate

GEBERIT BATHROOM CERAMICS

Geberit PurityS Wall-hung WC, Siphonic

- 171.007.01.1 Wall-hung WC
- 242.986.11.1 WC Seat Cover



Available Colours:



Pearl White
→ 224.198.00.1



Urban Grey
→ 224.198.00.3



Vulcan Black
→ 224.198.00.4



Pacific Blue
→ 224.198.00.2

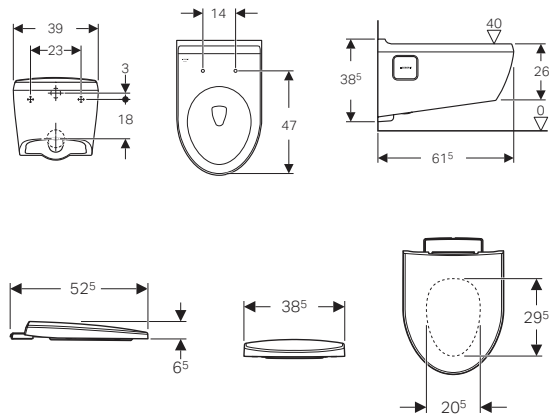

Geberit Universal One-Piece WC, Siphonic

- 171.020.00.1

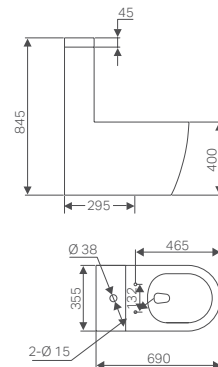

GEBERIT BATHROOM CERAMICS

Geberit iCon Wall-hung WC, Rimfree, Washdown



→ 204060000 Wall-hung WC

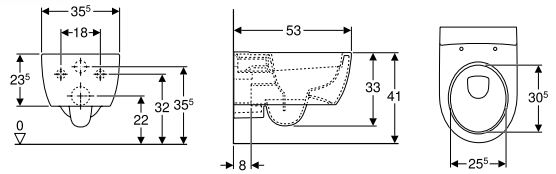

Geberit Smyle Wall-hung WC, Rimfree, Washdown



→ 500.215.01.1 Wall-hung WC

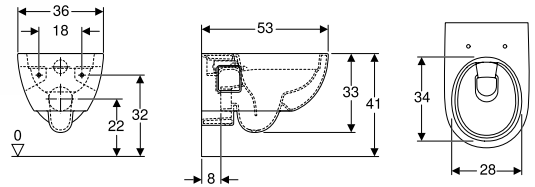

WC Seat Covers

Geberit iCon

→ 574120000

iCon WC Seat cover

→ 574130000

iCon WC Seat cover with soft-closing mechanism

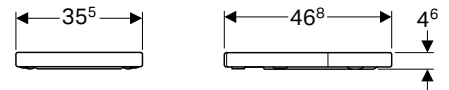

Geberit iCon, Slim design

→ 574950000

iCon WC Seat cover, slim design with soft-closing mechanism

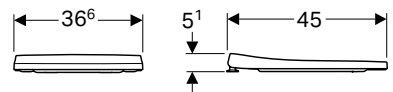

Geberit Smyle

→ 500.231.01.1

Smyle WC Seat cover

→ 500.232.01.1

Smyle WC Seat cover with soft-closing mechanism

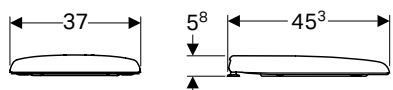

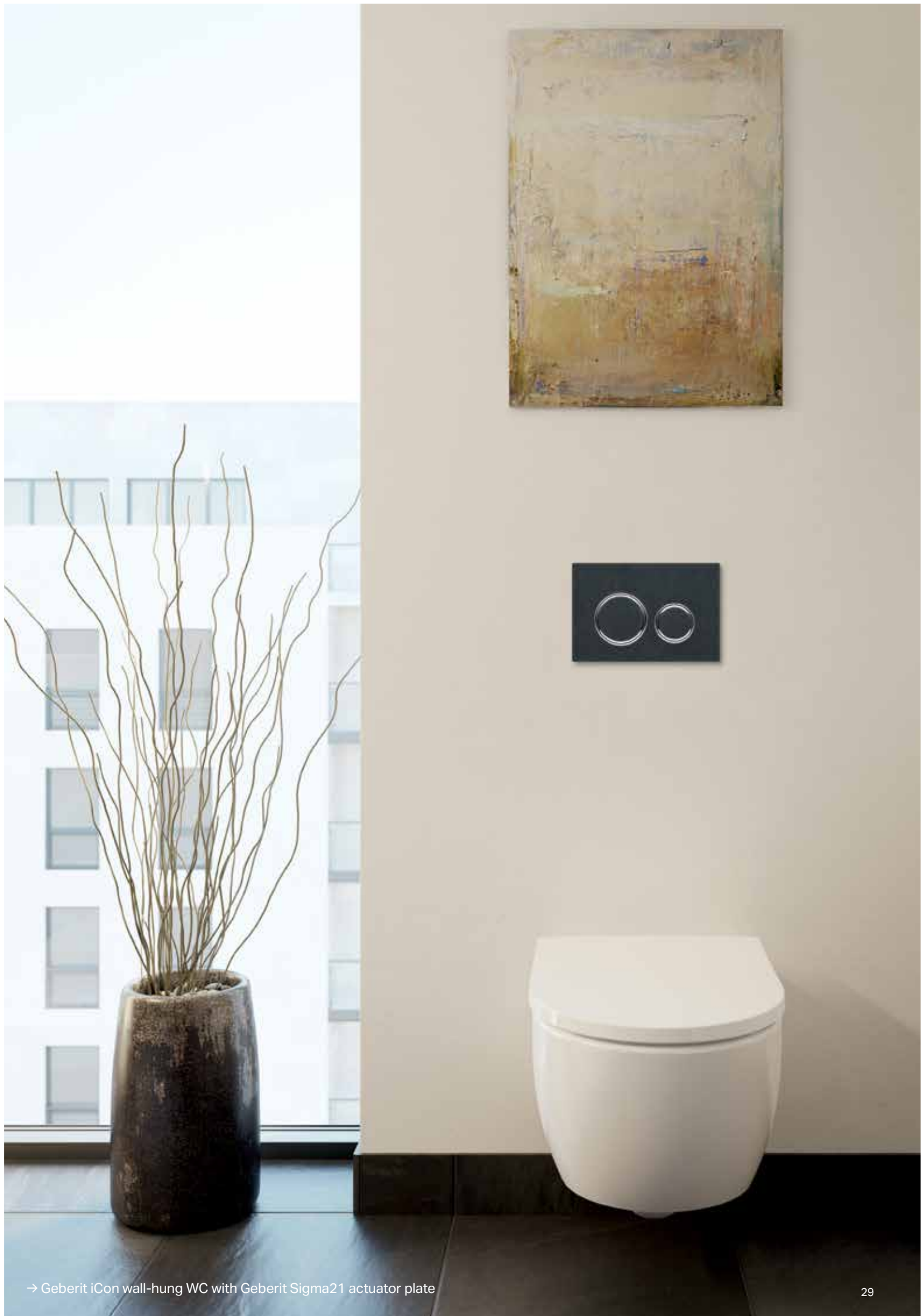

→ Geberit iCon wall-hung WC with Geberit Sigma21 actuator plate

GEBERIT AQUACLEAN SHOWER TOILETS

DESIGN MASTERPIECES



→ Geberit AquaClean Mera with Sigma70 actuator plate

DESIGN PLUS
powered by: ISH



red dot design award
winner 2015



DESIGN
AWARD
2016

GEBERIT AQUACLEAN SHOWER TOILETS

Geberit AquaClean Mera

- 146.214.11.1 Comfort, White alpine
- 146.214.21.1 Comfort, Bright-chrome plated
- 146.204.11.1 Classic, White alpine
- 146.204.21.1 Classic, Bright-chrome plated

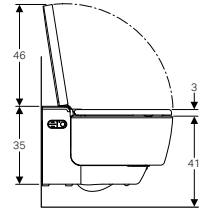

Geberit AquaClean Wall Mounted Control Panel

- 147.038.SI.1 White glass
- 147.038.SJ.1 Black glass



DESIGN PLUS
powered by: ISH

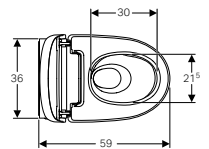
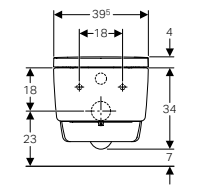

GEBERIT AQUACLEAN MERA FEATURES:



1 ODOUR EXTRACTION UNIT

불쾌한 냄새는 자동으로 실행되는 저소음 허니콤보 필터 시스템을 통해 정화가 됩니다.

2 DRYER

건조용 노즐을 통해 위생적이고 완벽한 건조가 가능합니다.



3 HEATING THE WC SEAT

인체 공학적 설계와 온열 기능이 장착된 고급 열경화성 수지 소재의 변기시트가 적용되었습니다. 사용자 접근시 근접 센서를 통해 온열기능이 작동 됩니다.

4 ORIENTATION LIGHT

근접 센서가 활성화 되어 부드러운 조명으로 시야를 유도하고 야간 이동 시 위치 확인이 가능합니다. 7가지 색상 중 선택 가능하며 밝기를 조절 할 수 있습니다.

GEBERIT AQUACLEAN SHOWER TOILETS

Geberit AquaClean Sela

- 146.224.11.1 White alpine
- 146.224.21.1 Bright-chrome plated

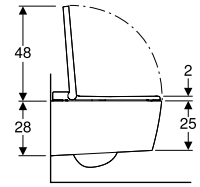

Geberit AquaClean Wall Mounted Control Panel

- 147.041.SI.1 White glass
- 147.041.SJ.1 Black glass



reddot design award
winner 2019

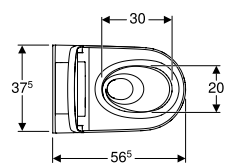
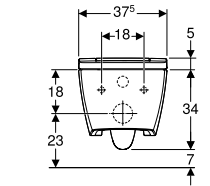

GEBERIT AQUACLEAN SELA FEATURES:



1 WHIRLSPRAY SHOWER TECHNOLOGY

특허받은 Whirl스프레이 기술을 적용하여 적은 물로도 쾌적하고 깨끗한 세정이 가능합니다.

2 RIMLESS CERAMIC PAN WITH TURBOFLUSH

혁신적인 TURBOFLUSH 기술이 Rimless 양변기에 적용된 제품입니다. 최적화된 수세 기술로 야간에도 조용하게 마음 편히 물을 내릴 수 있습니다.



3 REMOTE CONTROL AND APP

AquaClean Sela의 모든 기능을 리모콘으로 쉽게 사용할 수 있으며, Geberit App을 통해 각 기능을 설정 및 사용이 가능합니다.

4 ORIENTATION LIGHT

부드러운 조명으로 야간 이동 시 위치를 알 수 있습니다. 센서로 조절되는 무드등은 7가지 색상 중에서 선택 가능합니다.

GEBERIT AQUACLEAN SHOWER TOILETS

Geberit AquaClean Tuma

AquaClean Tuma, Wall-hung

- **146.294.11.1** Comfort, White alpine
- **146.294.SI.1** Comfort, White glass
- **146.294.SJ.1** Comfort, Black glass
- **146.294.FW.1** Comfort, Stainless steel brushed
- **146.094.11.1** Classic, White alpine

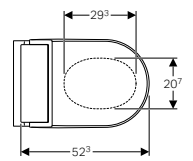
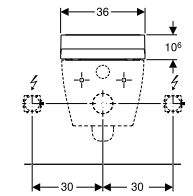
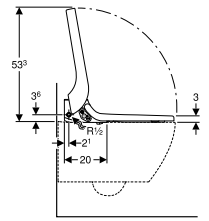

AquaClean Tuma, Floor-standing

- **146.310.11.1** Comfort, White alpine
- **146.310.SI.1** Comfort, White glass
- **146.310.SJ.1** Comfort, Black glass
- **146.310.FW.1** Comfort, Stainless steel brushed
- **146.320.11.1** Classic, White alpine

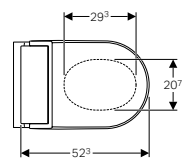
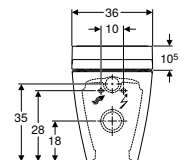
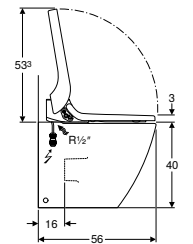

Geberit AquaClean Wall Mounted Control Panel

- **147.038.SI.1** White glass
- **147.038.SJ.1** Black glass



GEBERIT AQUACLEAN TUMA FEATURES:



1 WHIRLSPRAY SHOWER TECHNOLOGY

특히 받은 Whirl 스프레이는 세정력이 우수하여 쾌적한 기분을 느낄 수 있으며, 물 절약도 가능합니다.

2 RIMFREE WC CERAMIC APPLIANCE

Aquaclean의 Rimfree 양변기는 테두리에 Rim이 없어 청소가 용이하여 위생적으로 관리 할 수 있습니다.

GEBERIT AQUACLEAN MODEL OVERVIEW



	AQUACLEAN MERA		AQUACLEAN SELA
	COMFORT	CLASSIC	
WhirlSpray shower technology			
Rimless WC ceramic appliance with TurboFlush			
Rimless WC ceramic appliance			
Remote control			
Remote control app			
Programmable user profiles	4 profiles	4 profiles	4 profiles
Orientation light			
Number of adjustable shower pressure settings	5 levels	5 levels	5 levels
Individually adjustable spray arm position			
Adjustable water spray temperature			
Oscillating spray			
Lady shower			
WC seat heating			
Warm air dryer			
Odour extraction unit			
Touchless automatic mechanism for the WC lid			
SoftClosing			
QuickRelease function			
User recognition			
Descaling function			
Economy mode			



wall-hung

floor-standing

AQUACLEAN TUMA	
COMFORT	CLASSIC
4 profiles	1 profile (via app only)
5 levels	5 levels
	(via app only)
(via app only)	(via app only)
(lid only)	(lid only)

MODEL COLOURS:

AQUACLEAN MERA COMFORT AND CLASSIC AND AQUACLEAN SELA

- white alpine
- bright chrome-plated

AQUACLEAN TUMA COMFORT

- white alpine
- white glass
- black glass
- stainless steel brushed

THE FOLLOWING APPLIES FOR ALL MODELS:

전압/주파수: 230 V / 50-60 Hz.,
기본 수온 설정 37 °C,
절약 모드 < 0.5 W

NEW

GEBERIT SHOWER SOLUTIONS

SIMPLY CLEAN



→ Geberit CleanLine80 shower channel in champagne colour



reddot design award
winner 2015

GEBERIT CLEANLINE SHOWER CHANNEL

CleanLine80



NEW

Champagne, coated
Material: Stainless steel

→ **154.440.39.1**
Length: 30 - 90cm

→ **154.441.39.1**
Length: 30 - 130cm



NEW

Stainless steel, brushed
Material: Stainless steel

→ **154.440.KS.1**
Length: 30 - 90cm

→ **154.441.KS.1**
Length: 30 - 130cm



NEW

Black chrome, polished
Material: Stainless steel

→ **154.440.QC.1**
Length: 30 - 90cm

→ **154.441.QC.1**
Length: 30 - 130cm

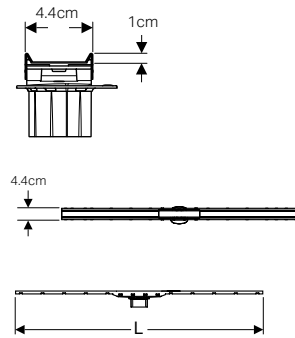

CleanLine60



Polished, brushed metal
Material: Stainless steel

→ **154.456.KS.1**
Length: 30 - 90cm

→ **154.457.KS.1**
Length: 30 - 130cm

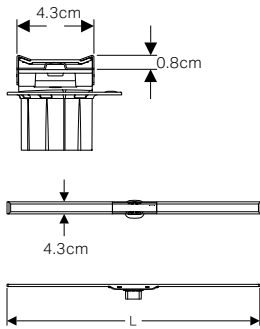

For Thin Floor

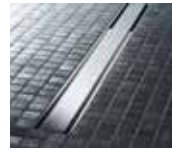

Brushed metal
Material: Stainless steel

→ **154.458.00.1**
Length: 30 - 90cm

→ **154.459.00.1**
Length: 30 - 130cm

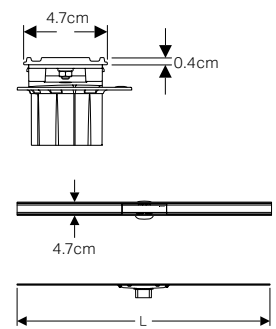

CleanLine20



Polished, brushed metal
Material: Stainless steel

→ **154.450.KS.1**
Length: 30 - 90cm

→ **154.451.KS.1**
Length: 30 - 130cm

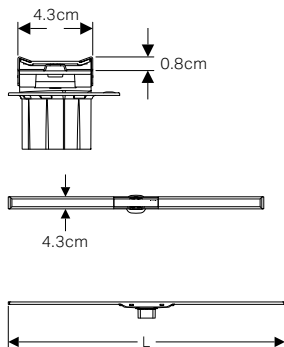

CleanLine Tile-bearing



Customised surface
Material: Stainless steel brushed

→ **154.455.00.1**

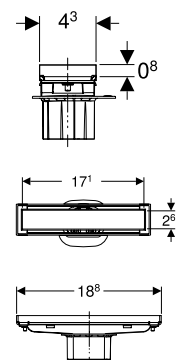

GEBERIT CLEANLINE SHOWER CHANNEL

CleanLine Installation Set

With waste trap

→ 154.150.00.1

Outlet diameter: 50mm

→ 154.151.00.1

Outlet diameter: 56mm

→ 154.152.00.1

Outlet diameter: 40mm

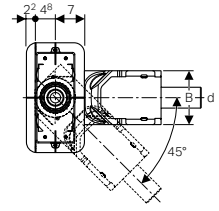
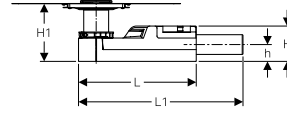

Without waste trap

→ 154.153.00.1

Outlet diameter: 50mm

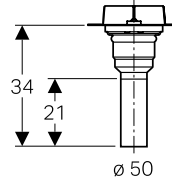

GEBERIT FLOOR DRAIN GRATING

Floor Drain Grating

Lockable

→ 154.310.00.1

Stainless steel brushed
Material: Stainless steel

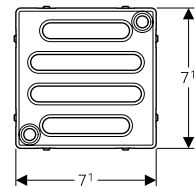
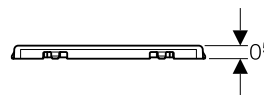

Circle

→ 154.311.00.1

Stainless steel brushed
Material: Stainless steel

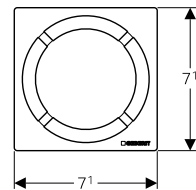
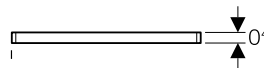
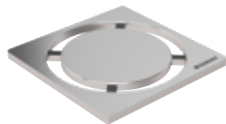

Square

→ 154.312.00.1

Stainless steel brushed
Material: Stainless steel

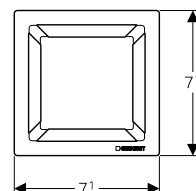
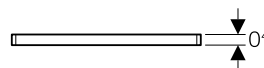
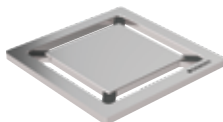

GEBERIT WALL DRAIN

Duofix Wall Drain, Half Frame

DESIGN PLUS
powered by: SH



→ **111.591.00.1**
Discharge outlet: 50mm

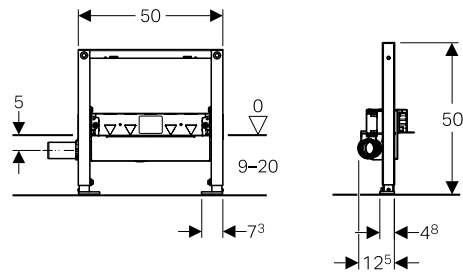

→ **111.593.00.1**
Discharge outlet: 40mm

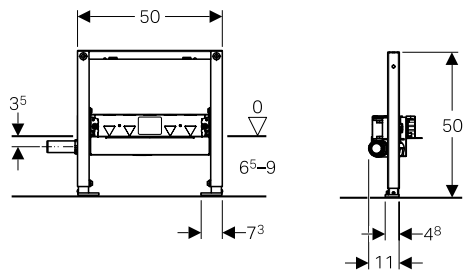

Kombifix Wall Drain

→ **457.534.00.1**
Discharge outlet: 50mm

Wall fastening set required
→ Art no: 111.815.00.1

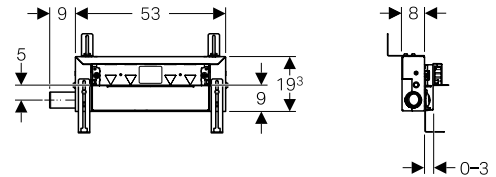

→ **457.536.00.1**
Discharge outlet: 40mm

Wall fastening set required
→ Art no: 111.815.00.1

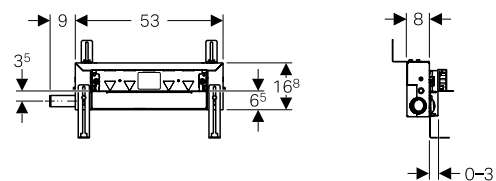

Wall Drain Cover

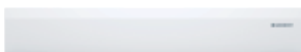
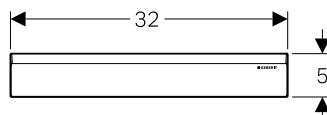

→ **154.335.11.1**
White
Material: Plastic



→ **154.335.21.1**
Bright chrome-plated
Material: Plastic



→ **154.336.FW.1**
→ **154.337.FW.1 (lockable)**
Stainless steel brushed
Material: Stainless steel



→ **154.338.00.1 (frameless)**
→ **154.339.00.1**
Customisable surface

GEBERIT PUBLIC SOLUTIONS

WELL ATTENDED



- Geberit VariForm square undercounter washbasins with Brenta wall-mounted sensor taps
- Geberit Smyle urinals with flush control Type 30



GEBERIT URINAL

Preda Urinal



With Integrated Sensor

→ 116.072.00.1
White alpine

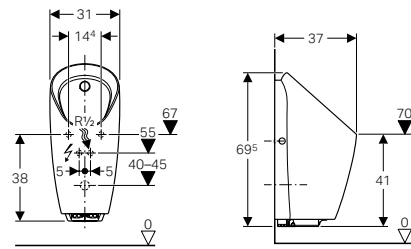

Without Integrated Sensor

→ 116.070.00.1
White alpine

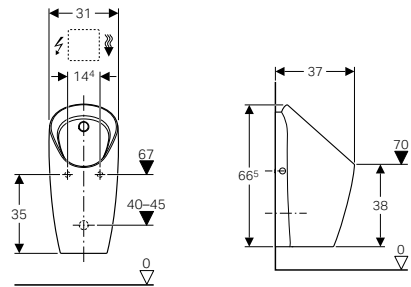

Waterless

→ 116.071.00.1
White alpine

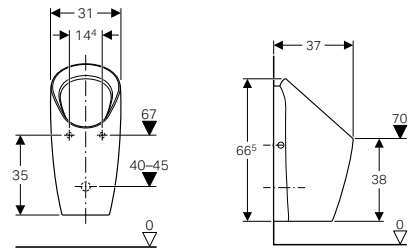

Smyle Urinal

→ 500.254.01.1
White

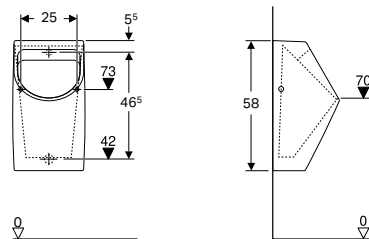

Pareo Urinal

→ 236100000
White

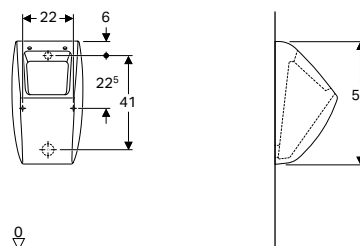

GEBERIT URINAL FLUSH CONTROL

Type 50

Flush technology:
sensor

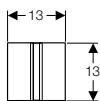

→ **116.026.GH.1**
Plate: Brushed chrome
Material: Die-cast zinc



NEW

→ **116.026.QB.1**
Plate: Red gold
Material: Die-cast zinc



NEW

→ **116.026.QD.1**
Plate: Black chrome
Material: Die-cast zinc

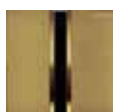

NEW

→ **116.026.QF.1**
Plate: Brass
Material: Die-cast zinc

Flush technology:
manual

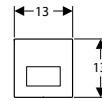

→ **116.016.00.5**
Plate: Customised surface
Material: Die-cast zinc



→ **116.016.11.5**
Plate: White alpine
Material: Die-cast zinc



→ **116.016.DW.5**
Plate: Jet black
Material: Die-cast zinc



→ **116.016.GH.5**
Plate: Brushed chrome
Material: Die-cast zinc



→ **116.016.SD.5**
Plate: Smoked glass reflective
Material: Die-cast zinc



→ **116.016.SE.5**
Plate: Green sanitised
Material: Die-cast zinc



→ **116.016.SQ.5**
Plate: Umber glass
Material: Die-cast zinc

Type 30

Flush technology:
sensor

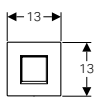

→ **116.027.KH.1**
Plate: Bright chrome
Material: Die-cast zinc



→ **116.027.KJ.1**
Plate: White alpine
Material: Die-cast zinc



→ **116.027.KM.1**
Plate: Black
Material: Die-cast zinc



→ **116.027.KN.1**
Plate: Matt chrome
Material: Die-cast zinc



→ **116.027.KX.1**
Plate: Brushed chrome
Material: Die-cast zinc

Flush technology:
manual

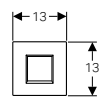

→ **116.017.KH.1**
Plate: Bright chrome
Stripes: Matt chrome
Material: Plastic



→ **116.017.KJ.1**
Plate: White alpine
Stripes: Bright chrome
Material: Plastic



→ **116.017.KK.1**
Plate: White alpine
Stripes: Gold
Material: Plastic



→ **116.017.KL.1**
Plate: White alpine
Stripes: Matt chrome
Material: Plastic



→ **116.017.KM.1**
Plate: Black
Stripes: Bright chrome
Material: Plastic



→ **116.017.KN.1**
Plate: Matt chrome
Stripes: Bright chrome
Material: Plastic

Type 10

Flush technology:
sensor



→ **116.025.KH.1**
Plate: Brushed chrome
Ring: Matt chrome
Material: Die-cast zinc



→ **116.025.KJ.1**
Plate: White
Ring: Bright chrome
Material: Die-cast zinc



→ **116.025.KK.1**
Plate: White
Ring: Gold
Material: Die-cast zinc



→ **116.025.KL.1**
Plate: White
Ring: Matt chrome
Material: Die-cast zinc



→ **116.025.KM.1**
Plate: Black
Ring: Bright chrome
Material: Die-cast zinc



→ **116.025.KN.1**
Plate: Matt chrome
Ring: Bright chrome
Material: Die-cast zinc



→ **116.025.SN.1**
Plate: Brushed
Ring: Polished
Material: Stainless steel

Flush technology:
manual



→ **116.015.KH.1**
Plate: Bright chrome
Ring: Matt chrome
Material: Plastic



→ **116.015.KJ.1**
Plate: White
Ring: Bright chrome
Material: Plastic



→ **116.015.KK.1**
Plate: White
Ring: Gold
Material: Plastic



→ **116.015.KL.1**
Plate: White
Ring: Matt chrome
Material: Plastic



→ **116.015.KM.1**
Plate: Black
Ring: Bright chrome
Material: Plastic



→ **116.015.KN.1**
Plate: Matt chrome
Ring: Bright chrome
Material: Plastic



→ **116.015.SN.1**
Plate: Brushed
Ring: Polished
Material: Stainless steel

Type 01

Flush technology:
sensor



→ **116.021.11.5**
Plate: White alpine
Material: Die-cast zinc



→ **116.021.21.5**
Plate: Bright chrome
Material: Die-cast zinc



→ **116.021.46.5**
Plate: Matt chrome
Material: Die-cast zinc

Flush technology:
manual



→ **116.011.11.5**
Plate: White alpine
Material: Plastic



→ **116.011.21.5**
Plate: Bright chrome
Material: Plastic



→ **116.011.46.5**
Plate: Matt chrome
Material: Plastic

Urinal Flush Control with Manual Override

Flush technology:
sensor, manual



→ **117.009.00.1**
Plate: Black
Material: Tempered glass

GEBERIT URINAL DIVISION PANEL

Urinal Division Panel

→ **115.201.11.1**
 White alpine
 Material: Plastic

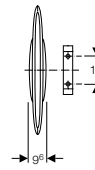
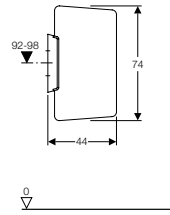

→ **115.202.11.1**
 White alpine
 Material: Plastic

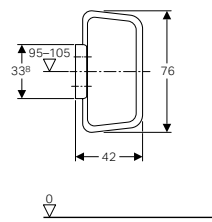

→ **115.211.CD.1**
 Grey
 Material: Glass

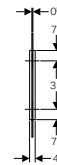
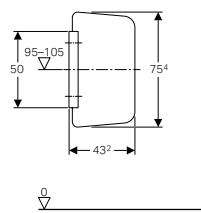

→ **115.211.TD.1**
 White alpine
 Material: Glass

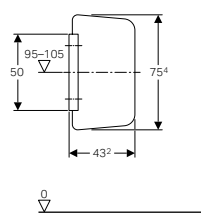

→ **115.211.TF.1**
 Umber
 Material: Glass

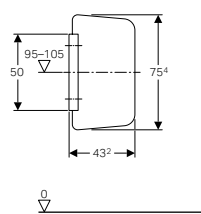

GEBERIT SENSOR TAP



Deck-mounted Sensor Tap

Brenta



With exposed function box
Mains operation

→ **116.171.21.1**
Without mixer
Surface: Bright chrome

→ **116.172.21.1**
With mixer
Surface: Bright chrome



With concealed function box
Mains operation

→ **116.191.21.1**
Without mixer
Surface: Bright chrome

→ **116.192.21.1**
With mixer
Surface: Bright chrome

Piave



With exposed function box
Mains operation

→ **116.161.21.1**
Without mixer
Surface: Bright chrome

→ **116.162.21.1**
With mixer
Surface: Bright chrome



With concealed function box
Mains operation

→ **116.181.21.1**
Without mixer
Surface: Bright chrome

→ **116.182.21.1**
With mixer
Surface: Bright chrome

Wall-mounted Sensor Tap

Brenta



With concealed function box
Mains operation

→ **116.271.21.1**
Without mixer
Surface: Bright chrome
Length: 17cm

→ **116.272.21.1**
Without mixer
Surface: Bright chrome
Length: 17cm



With concealed function box
Mains operation

→ **116.291.21.1**
Without mixer
Surface: Bright chrome
Length: 22cm

→ **116.292.21.1**
With mixer
Surface: Bright chrome
Length: 22cm

Piave



With concealed function box
Mains operation

→ **116.261.21.1**
Without mixer
Surface: Bright chrome
Length: 17cm

→ **116.262.21.1**
Without mixer
Surface: Bright chrome
Length: 17cm



With concealed function box
Mains operation

→ **116.281.21.1**
Without mixer
Surface: Bright chrome
Length: 22cm

→ **116.282.21.1**
With mixer
Surface: Bright chrome
Length: 22cm

ACCESSORIES FOR SENSOR TAP & MIXER

Duofix Element for Washbasin

For Deck-mounted tap

→ **111.553.00.1**

Height: 112cm
Deck-mounted tap
With concealed function box

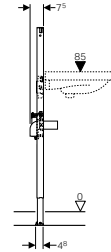
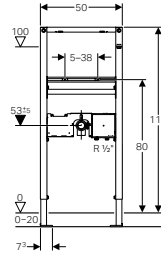

→ **111.563.00.1**

Height: 112cm
Deck-mounted tap
With concealed function box and concealed trap

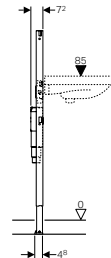
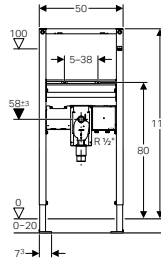

For Wall-mounted tap

→ **111.560.00.1**

Height: 130cm
Wall-mounted tap
With concealed function box

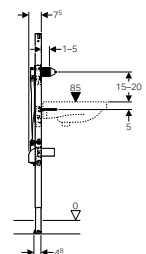
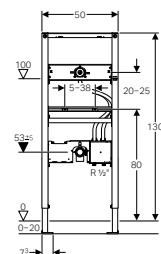

→ **111.562.00.1**

Height: 130cm
Wall-mounted tap
With concealed function box and concealed trap

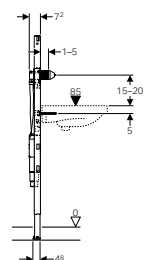
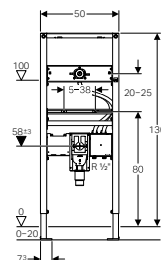

ACCESSORIES FOR SENSOR TAP & MIXER

Duofix Element for Washbasin

For Washbasin ceramics

→ **224.059.00.1**
 Height: 88cm
 For wall-hung basin

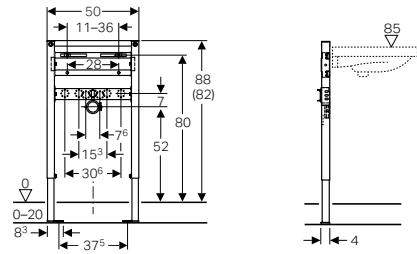

→ **111.434.00.1**
 Height: 112cm
 For wall-hung basin

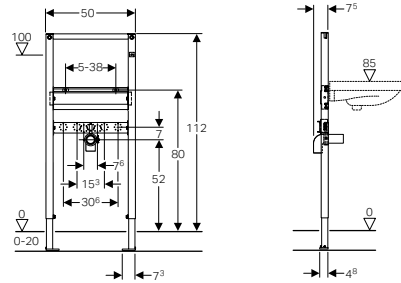

Cover Plate

→ **116.425.11.1**
 White alpine
 For concealed function box

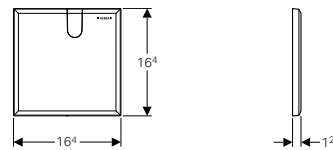

→ **116.426.11.1**
 White alpine
 For concealed function box and concealed trap

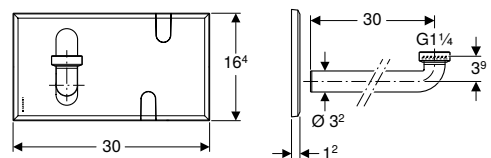

BATHROOM SOLUTIONS THAT MEET YOUR NEEDS

BETTER BATHROOMS

완벽한 욕실에 대한 기대는 고객마다 다릅니다. Geberit은 고객이 가장 중요하게 여기는 것이 무엇인지 고민하고 연구하여 가장 중요한 5가지 특성, 디자인, 청결함, 유용성 및 편안함과 공간 절약에 대한 솔루션을 발견했습니다.

고객마다 우선 순위가 다르기 때문에 Geberit은 다양한 요구 사항에 맞게 특별한 욕실 시스템을 제공합니다. 아래 표를 통해 특수한 요구 사항과 생활 여건에 맞는 욕실 시리즈를 빠르게 확인할 수 있습니다.



DESIGN

현대적인 우아함과 다양한 색상을 찾는 고객들을 위해 쉽게 설치 되고 시대를 초월한 아름다운 디자인의 제품



CLEANLINESS

청소작업을 최소화 하고 청결함을 우선으로 생각하는 고객들을 위한 먼지가 거의 없고 청소하기 쉬운 제품



USABILITY

욕실 리모델링 후 최상의 욕실 기능을 즐기면서 동시에 안전을 원하는 고객들을 위한 사용하기 쉬운 제품



COMFORT

웰빙 및 청결함을 원하는 모든 고객들을 위한 욕실에 편안함과 깨끗함을 주는 제품



COMPACT OPTION

기능이나 저장 공간을 타협하고 싶지 않은 고객들을 위한 공간을 극대화 하는 기능과 제품



ACCESSIBILITY

연령이나 특정한 요구 조건과 상관없이 보편적인 디자인을 원하는 고객들을 위한 접근이 용이한 욕실

	DESIGN 	CLEANLINESS 	USABILITY 	COMFORT 	COMPACT OPTION 	ACCESSIBILITY 
Geberit Citterio	✓	✓	✓	✓	✓	
Geberit Xeno ²	✓	✓	✓	✓	✓	
Geberit myDay	✓	✓	✓	✓	✓	
Geberit Acanto	✓	✓	✓	✓	✓	
Geberit iCon	✓	✓	✓	✓	✓	
Geberit Smyle	✓	✓	✓	✓	✓	
Geberit Selnova		✓	✓	✓	✓	
Geberit Selnova Square	✓	✓	✓	✓	✓	
Geberit Selnova Comfort	✓	✓	✓	✓		✓
Geberit VariForm	✓	✓	✓	✓	✓	

CLEANLINESS

THE KERATECT SPECIAL GLAZE

Geberit KeraTect 특수 코팅 기술은 도기 표면을 오래동안 보호해 줍니다.

KeraTect 특수 코팅 기술은 유약으로 구워지며 표면이 매우 매끄러워 간편하고 효율적이며 깨끗하게 유지될 수 있습니다.

KeraTect 특수 코팅:

- 다공성이 거의 없고 매우 부드러움
- 방진성, 위생성 및 청결함
- 청소 및 관리의 용이함
- 내구성 및 긁힘 방지



KeraTect

CLEANLINESS

EASY TO CLEAN: RIMFREE

욕실에서는 청결과 위생이 가장 중요하기 때문에 욕실을 깨끗하게 유지하는 것은 필수적입니다. 하지만 양변기는 테두리 부분을 청소 할 때 번거로움이 있으며, 대부분의 고객들은 신경을 쓰지 못하는 경우도 있습니다.

이러한 문제점을 보완하고 배수력 또한 향상시키기 위해 Rimfree 기술이 도입 되었습니다. Geberit은 이러한 신기술을 도입하여 양변기의 세척력을 높여가고 있습니다.

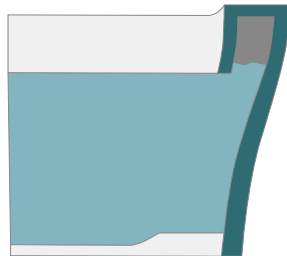

↑
일반적인 양변기는 쉽게 청소가 되지 않는 세척 림(Flush rim)이 존재 합니다. 손이 닿기 어려운 이 부분에 먼지와 박테리아가 쌓여 불쾌한 냄새가 나기도 합니다.

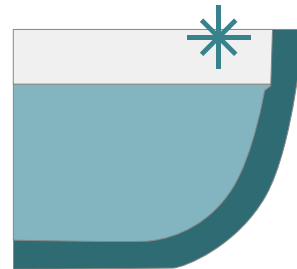

↑
그러나 Geberit Rimfree 기술에는 림이 없습니다. Geberit Rimfree 양변기의 매끄러운 내부 표면은 단 한 번의 청소로 깨끗해 집니다. 그리고 무엇보다도 얼룩이 깨끗하게 제거되었는지 확인할 수 있습니다.

Rimfree

GEBERIT BATHROOM COLLECTION

BETTER BATHROOMS



→ Geberit Citterio Bathroom Series



→ Geberit Citterio



→ Geberit Xeno²



→ Geberit myDay



→ Geberit Acanto



→ Geberit iCon



→ Geberit Smyle



DESIGN
AWARD
2018





→ Geberit Bathtubs

THE EFFECTIVE RAIN SOLUTION

GEBERIT 지붕 우배수 시스템

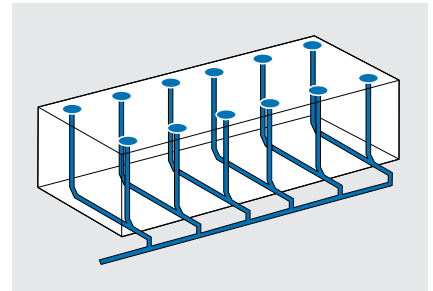

↑
중력식 우배수 시스템

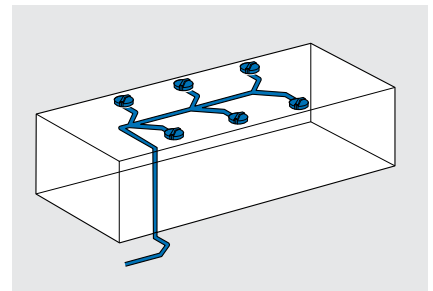

↑
Geberit Pluvia 사이포닉 우배수 시스템

NOT AFRAID OF CATS AND DOGS

Geberit Pluvia 사이포닉 우배수 시스템에는 Geberit HDPE 로 만든 지붕 아웃렛과 배관 및 피팅류가 포함됩니다. 기존 중력식 우배수 방법과 달리 Geberit Pluvia 시스템은 사이펀(음압) 현상을 발생시켜 빠른 속도로 배수 되는 시스템입니다. 배수관내에 물이 가득차게 되면 음압을 형성하여 빗물을 빠른 속도로 빨아 들입니다. 또한 빠른 유속에 의해 배관내의 자정 작용을 항상 시킵니다.

Geberit Pluvia 시스템은 기존 중력식 우수 배관 시스템 보다 작은 관경을 사용하고 최소한의 입상 배관과 지하 배관을 사용하기 때문에 비용과 설치 시간면에서 효과적입니다.

Geberit Pluvia 시스템은 수평 배관의 구배 없이 설치 할 수 있습니다.

Geberit ProPlanner(우수배관 설계 프로그램을) 사용 하여 설계 단계 부터 공정을 단순화 하고 시공 시간을 단축 할 수 있는 가장 이상적인 우배수 시스템의 전과정을 지원 합니다.

지붕의 종류에 따른 다양한 용량의 Geberit Pluvia 아웃렛이 설치 가능합니다. Geberit Pluvia 우배수 시스템과 함께 효과적이며 경제적인 건축물을 설계 할 수 있습니다.

10 GOOD REASONS TO GO FOR GEBERIT PLUVIA

- 광범위한 적용성
- 공간 절약
- 지붕 아웃렛 수량 최소화
- 설치 비용 절약
- 현장 시공 시간 단축
- 사이펀 현상을 활용한 시스템
- 입상 배관 최소화
- 작은 배관 관경 사용
- 지하 배관 및 맨홀 갯수 단축
- 모든 종류의 지붕 디자인에 적용 가능

- 35년 이상의 경험
- 공장, 창고, 쇼핑몰, 공항, 호텔, 스포츠 센터 등 각종 지붕 디자인 설계에 적용 가능
- 높은 안정성 및 뛰어난 내구성
- 가벼운 무게
- 초당 최대 25 리터 빗물 배수



NEW

- 더 넓은 생활 공간
- 간단한 설계와 쉬운 시공
- 보다 작은 입상관경
- 무통기 배관 시스템
- 무구배 수평관(최대 6미터)

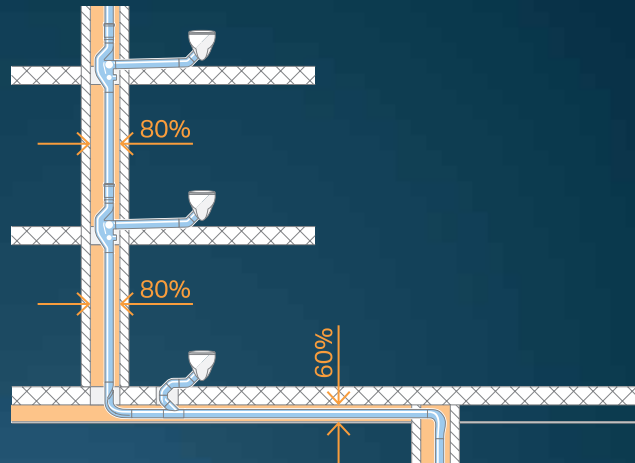

↑
Geberit SuperTube saves space in every direction.

* Up to 6 metres

→ Geberit SuperTube technology

DRAINING AT THE HIGHEST STAGE

GEBERIT 배수 시스템



↑
**GEBERIT HDPE
THE MULTI-PURPOSE SOLUTION**

Geberit HDPE 배수 시스템은 최적의 성능을 제공합니다. 열융착 방식으로 쉽게 연결할 수 있으며, 내화학적, 내열성, 내충격성 뿐만 아니라 콘크리트에 매립하여 설치할 수 있는 수준의 완벽한 방수성과 매우 높은 강도를 보증합니다. Geberit HDPE 파이프는 사전 제작된 각각의 배관 시스템을 현장에서 간단하게 연결하고 시공 함으로서 공정 단축 및 비용 절감에 기여합니다. 또한 사전 제작된 HDPE 배관 시스템은 무게가 가벼워 현장에서 운반이 매우 용이합니다.

REASONS FOR GEBERIT HDPE:

- 내충격 및 쉬운 설치
- 완벽한 누수 방지 기능
- 강한 내화학적 및 내열성
- 다양한 범위의 배관 환경
- 콘크리트 매립 시공 가능
- 선조립 가능



↑
**GEBERIT SUPERTUBE
THE SPACE-GAINING SYSTEM**

Geberit SuperTube 시스템은 각 구성 요소간의 완벽한 상호작용을 기반으로 작동되는 무통기 배수 시스템입니다. 특허받은 3개의 피팅 제품과 높은 하중 지지능력이 검증된 Geberit HDPE 배관이 결합된 혁신적인 배수 시스템이며 영구적으로 완벽하게 융착되어 누수 걱정이 없습니다.

GEBERIT SUPERTUBE PROS:

- 고층 건물을 위한 무통기 배수 시스템
- 최대 40% 까지 더 넓어지는 생활 공간 활용
- 수평 배관*
- Geberit HDPE, Silent-db20와 호환
- 간편한 설계 및 설치
- 작은 관경의 배관 사용
- 별도 통기배관 설치 필요 없음
- 기존 배수 배관 시스템 보다 뛰어난 경제성



↑
**GEBERIT SILENT-DB20
MUTED SOUNDS**

Geberit Silent db20은 미네랄 강화 HDPE(Mineral Reinforced HDPE) 소재로 생산되어 뛰어난 방음효과를 자랑하며 방음 및 자외선 차단 성능이 뛰어 납니다. 배관의 주름 디자인은 배관내 유체 흐름의 완충작용을 통해 진동을 감소시켜 최소화 시킵니다.

THE SOUND OF SILENCE:

- Geberit HDPE와 동일한 특성
- 뛰어난 방음 효과
- 다양한 규격의 배관 및 피팅
- 유체 역학 최적의 피팅
- 영구적인 수명과 안정성



- 피팅류, 배관 및 압착 도구로 최적화된 급수 배관 시스템
- 안전 설치: 압착 연결 되지 않은 연결 구간의 분명한 식별 가능
- 엄격한 품질 요구 조건으로 누수 없이 영구적인 사용
- 특수 피팅을 사용하여 배관 변경 용이

→ Geberit Mapress supply system

SIMPLY CONNECTED

THE GEBERIT SUPPLY SYSTEMS



↑
**DON'T STRESS. PRESS.
EASY ASSEMBLING**

배관을 설치할 때는 안전성과 내구성을 바탕으로 빠른 설치가 최우선 과제입니다. Geberit Mapress와 Geberit Mepla는 이러한 필요 조건에 완벽히 적합한 급수 배관 시스템입니다. 다양한 피팅류를 사용하여 다른 배관 시스템과도 문제 없이 설치가 가능합니다.



↑
**GEBERIT MAPRESS
THE ALL-ROUND TALENT**

위생이나 온도, 압력, 부식에 관해서는 주거 뿐만 아니라 산업 설비에서도 그 가치가 입증된 Geberit Mapress Stainless Steel이 언제나 후회 없는 선택을 보장합니다. Geberit Mapress Stainless Steel은 스프링클러 시스템에 사용되기 위한 VdS 승인을 포함, 모든 관련된 국제적인 인증을 받은 제품입니다.

THE ALLROUND TALENT:

- 높은 수준의 식수 위생 및 높은 하중 지지능력 요구 환경에 사용 가능
- 강한 내화학 및 내열성
- 4가지 종류의 Seal ring 을 사용하여 다양한 산업 분야에 적용 가능
- 압착 연결 되지 않는 연결 구간의 분명한 식별 가능
- 다양한 관경: 12~108 mm 11종 규격, 약 500여개의 피팅류
- Geberit Mepla 및 다른 Geberit Mapress 제품 소재와 호환 연결 가능

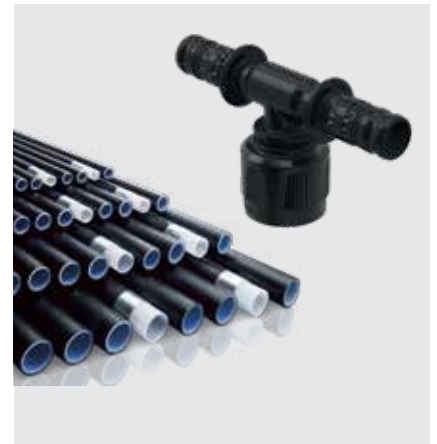

↑
**GEBERIT MEPLA
THE VERSATILE OPTION**

Geberit Mepla 배관은 플라스틱과 금속의 장점들을 결합한 3중 복합(PExb -알루미늄 - HDPE) 급수 배관 시스템 입니다. 배관 내부층은 부식 방지 및 위생 안전을 위해 PExb 재질로 되어 있으며 중간층은 안정적이며 보다 쉽게 벤딩을 할 수 있는 알루미늄 재질로 되어 있습니다. 또한 외부층은 부식 및 내충격성에 강한 HDPE 재질로 배관을 감싸고 있습니다. 배관 연결 피팅류들은 압착 방식으로 연결 되어 누수 없이 안전하게 사용할 수 있는 강한 압착력을 보장합니다, Geberit Mepla의 다양한 장점들로 인해 음용수 뿐만 아니라 다양한 산업 분야에 사용되고 있습니다.

FAST AND FLEXIBLE:

- 안정적이고 유연하며 강한 내부식성
- 압착 되지 않는 연결 구간의 분명한 식별 가능
- 압력에 높은 저항성
- 배관 연결 부위의 완벽한 위생적 결합
- 내화학성 및 내열성
- 음용수 품질에 적합
- 특수 피팅을 사용하여 배관 변경 용이
- Geberit Mapress 에 연결 가능

Geberit Korea

06105 서울시 강남구 논현로 128길
3층 301호

전화: 02-543-4166

팩스: 02-543-4123

sales.kr@geberit.com

www.geberit.co.kr



Geberit Corporate Video